

FEATURES

- Patents pending
- Lower Profile
- UL60950 Recognition pending
- ANSI/AAMI ES60601-1 Recognition pending
- 3kVDC Isolation “Hi Pot Test”
- Substrate Embedded Transformer
- Automated Manufacture
- Industry Standard Footprint
- Short Circuit Protection³
- Halogen Free

PRODUCT OVERVIEW

The NXE2 series is a new range of low cost, lower profile, fully automated manufacture surface mount DC/DC converters. The NXE2 series automated manufacturing process with substrate embedded transformer, offers increased product reliability and repeatability of performance in a halogen free, iLGA inspectable package. The NXE2 series, industry standard footprint is compatible with existing designs.

The NXE2 series has a MSL rating 2, and is compatible with a peak reflow solder temperature of 245°C as per J-STD-020 and J-STD-075.



SELECTION GUIDE

Order Code ¹	Nominal Input Voltage	Output Voltage	Input Current	Output Current	Load Regulation (Typ)	Load Regulation (Max)	Output Ripple & Noise (Typ)	Output Ripple & Noise (Max)	Efficiency (Min)	Efficiency (Typ)	Isolation Capacitance	MTTF ²	
	V	V	mA	mA	%	%	mVp-p	mVp-p	%	%		pF	MIL
													kHrs
NXE2S0505MC	5	5	542	400	9	12	55	85	68.5	72	2.1	1853	18868
NXE2S1205MC	12	5	220	400	10.5	12	50	85	74.5	77	2.1	2163	15152
NXE2S1212MC	12	12	210	167	7	8.5	25	55	74.5	76.5	2.1	1848	22472
NXE2S1215MC	12	15	205	133	8.5	11	30	60	76	79	2.1	2181	22472

INPUT CHARACTERISTICS

Parameter	Conditions	Min.	Typ.	Max.	Units
Voltage range	Continuous operation, 5V input types	4.5	5	5.5	V
	Continuous operation, 12V input types	10.8	12	13.2	
Input reflected ripple current	NXE2S0505MC		4		mA p-p
	NXE2S1205MC		2.5		
	NXE2S1212MC		3.3		
	NXE2S1215MC		2.8		

ISOLATION CHARACTERISTICS

Parameter	Conditions	Min.	Typ.	Max.	Units
Isolation voltage	Flash tested for 1 second	3000			VDC
Resistance	Viso= 1000VDC	10			GΩ

GENERAL CHARACTERISTICS

Parameter	Conditions	Min.	Typ.	Max.	Units
Switching frequency	NXE2S0505MC		130		kHz
	NXE2S1205MC		100		
	NXE2S1212MC		115		
	NXE2S1215MC		100		

OUTPUT CHARACTERISTICS

Parameter	Conditions	Min.	Typ.	Max.	Units
Rated power	T _A =-40°C to 85°C			2.0	W
Voltage set point accuracy	See tolerance envelopes				
Line regulation ⁴	High V _{IN} to low V _{IN} , All other variants		1.15	1.2	%/%
	High V _{IN} to low V _{IN} , 1205 variant		1.15	1.26	

TEMPERATURE CHARACTERISTICS

Parameter	Conditions	Min.	Typ.	Max.	Units
Specification	See derating graphs	-40		85	°C
Storage		-50		125	
Case temperature rise above ambient	NXE2S0505MC		36		
	NXE2S1205MC		32		
	NXE2S1212MC		28		
	NXE2S1215MC		26		
Cooling	Free air convection				

ABSOLUTE MAXIMUM RATINGS

Input voltage V _{IN} , NXE2S05 types	7V
Input voltage V _{IN} , NXE2S12 types	15V

1. Components are supplied in tape and reel packaging, please refer to package specification section. Orderable part numbers are NXE2S0505MC-R7 (180 pieces per reel), or NXE2S0505MC-R13 (800 pieces per reel).

2. Calculated using MIL-HDBK-217 FN2 and Telcordia SR-332 calculation model with nominal input voltage at full load.

3. Please refer to short circuit application notes.

4. NXE2S1205MC line regulation may increase to 2.15 %/% at the operating temperature limits.

All specifications typical at T_A=25°C, nominal input voltage and rated output current unless otherwise specified.

TECHNICAL NOTES

ISOLATION VOLTAGE

'Hi Pot Test', 'Flash Tested', 'Withstand Voltage', 'Proof Voltage', 'Dielectric Withstand Voltage' & 'Isolation Test Voltage' are all terms that relate to the same thing, a test voltage, applied for a specified time, across a component designed to provide electrical isolation, to verify the integrity of that isolation.

Murata Power Solutions NXE2 series of DC/DC converters are all 100% production tested at their stated isolation voltage. This is 3kVDC for 1 second.

A question commonly asked is, "What is the continuous voltage that can be applied across the part in normal operation?"

When the insulation in the NXE2 series is not used as a safety barrier, i.e. provides functional isolation only, continuous or switched voltages across the barrier up to 3kV are sustainable. Long term reliability testing at these voltages continues. Peak Inception voltages measured were in excess of 3.5kV when testing for partial discharge in accordance with IEC 60270. Please contact Murata for further information.

The NXE2 series is pending recognition by Underwriters Laboratory.

REPEATED HIGH-VOLTAGE ISOLATION TESTING

It is well known that repeated high-voltage isolation testing of a barrier component can actually degrade isolation capability, to a lesser or greater degree depending on materials, construction and environment. The NXE2 series has a PCB embedded isolated transformer, using FR4 as an insulation barrier between primary and secondary windings. While parts can be expected to withstand several times the stated test voltage, the isolation capability does depend on the FR4 insulation properties. Any material, including FR4 is susceptible to eventual chemical degradation when subject to very high applied voltages thus implying that the number of tests should be strictly limited. We therefore strongly advise against repeated high voltage isolation testing, but if it is absolutely required, that the voltage should be reduced by 20% from specified test voltage.

This consideration equally applies to agency recognized parts rated for better than functional isolation where the insulation is always supplemented by a further insulation system of physical spacing or barriers.

SAFETY APPROVAL

ANSI/AAMI ES60601-1

The NXE2 series is pending recognition ANSI/AAMI ES60601-1.

UL 60950

The NXE2 series is pending recognition by Underwriters Laboratory (UL) to UL 60950.

FUSING

The NXE2 Series of converters are not internally fused so to meet the requirements of UL an anti-surge input line fuse should always be used with ratings as defined below.

Input Voltage, 5V 1A

Input Voltage, 12V 400mA

All fuses should be UL recognized, V rated.

CHARACTERISATION TEST METHODS

Ripple & Noise Characterisation Method

Ripple and noise measurements are performed with the following test configuration.

C1	1µF X7R multilayer ceramic capacitor, voltage rating to be a minimum of 3 times the output voltage of the DC/DC converter
C2	10µF tantalum capacitor, voltage rating to be a minimum of 1.5 times the output voltage of the DC/DC converter with an ESR of less than 100mΩ at 100 kHz
C3	100nF multilayer ceramic capacitor, general purpose
R1	450Ω resistor, carbon film, ±1% tolerance
R2	50Ω BNC termination
T1	3T of the coax cable through a ferrite toroid
RLOAD	Resistive load to the maximum power rating of the DC/DC converter. Connections should be made via twisted wires

Measured values are multiplied by 10 to obtain the specified values.

Differential Mode Noise Test Schematic

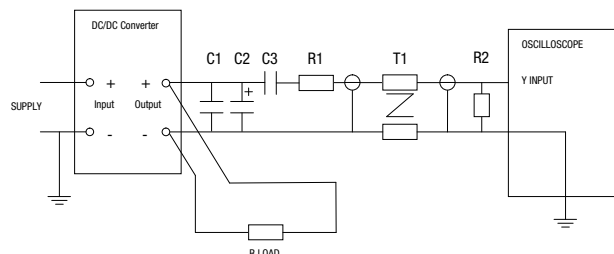

RoHS COMPLIANCE, MSL AND PSL INFORMATION



This series is compatible with Pb-Free soldering systems and is also backward compatible with Sn/Pb soldering systems. The NXE2 series has a process, moisture, and reflow sensitivity classification of MSL2 PSL R7F as defined in J-STD-020 and J-STD-075. This translates to: MSL2 = 1 year floor life, PSL R7F = Peak reflow temperature 245°C with a limitation on the time above liquidus (217°C) which for this series is 90sec max. The pin termination finish on this product series is Gold with a plating thickness of 0.12 microns.

TOLERANCE ENVELOPES

The voltage tolerance envelopes show typical load regulation characteristics for this product series. The tolerance envelope is the maximum output voltage variation due to changes in output loading and set point accuracy. NXE2S1205MC & NXE2S1212MC output voltage will be outside the tolerance envelope at operating temperature limits.

NXE2S0505MC

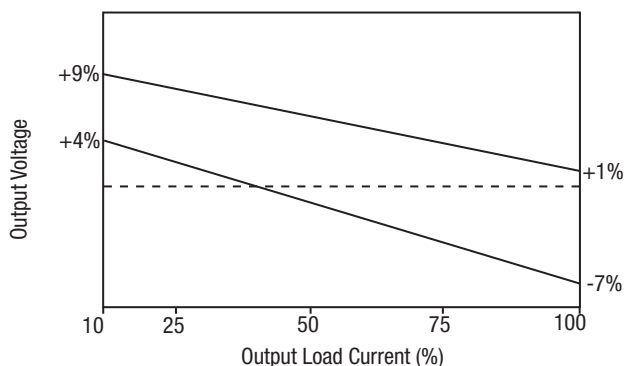

NXE2S1205MC

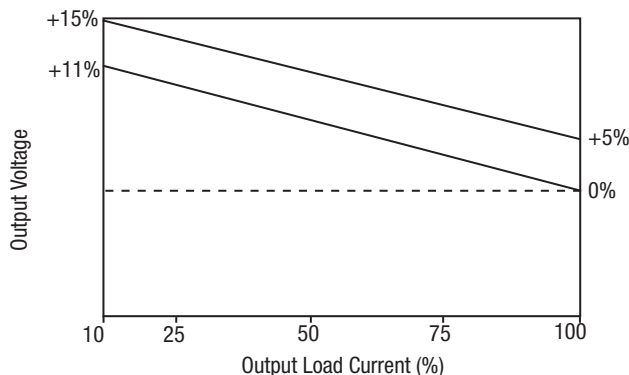

NXE2S1212MC

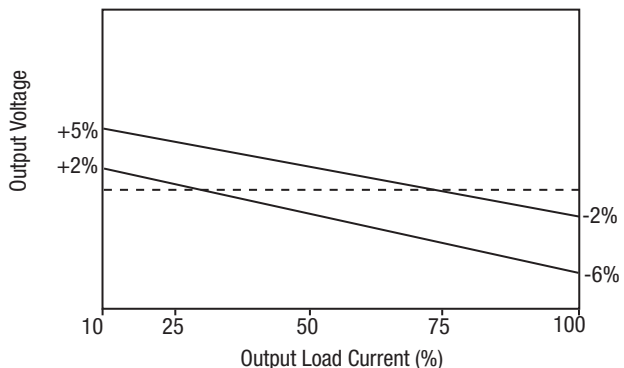

NXE2S1215MC

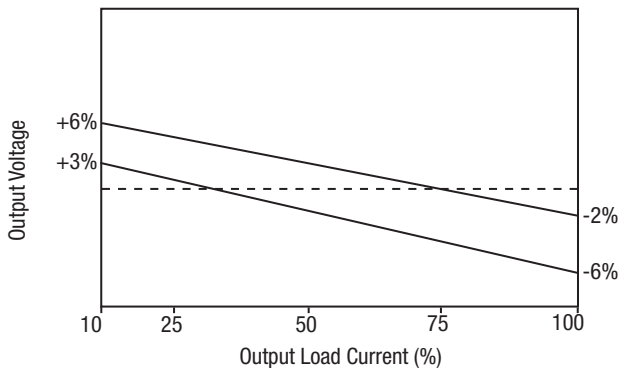

EFFICIENCY VS LOAD

NXE2S0505MC

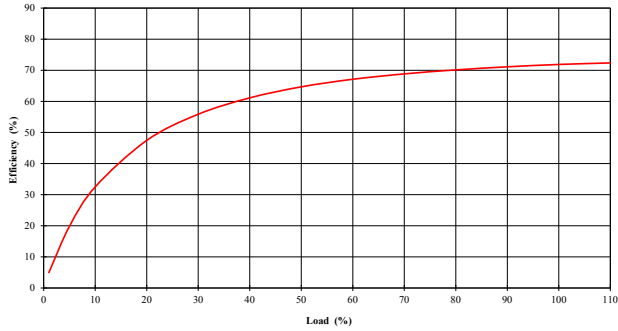

NXE2S1205MC

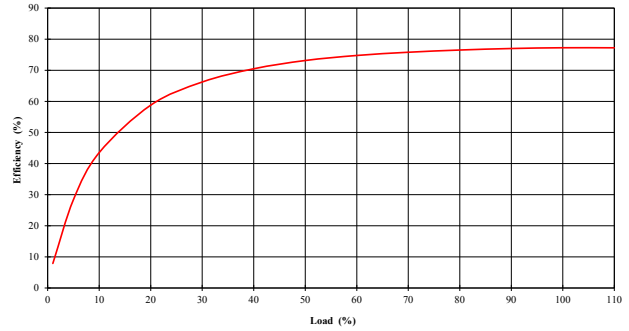

NXE2S1212MC

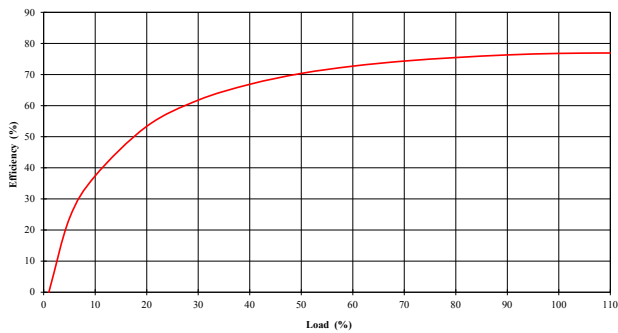

NXE2S1215MC

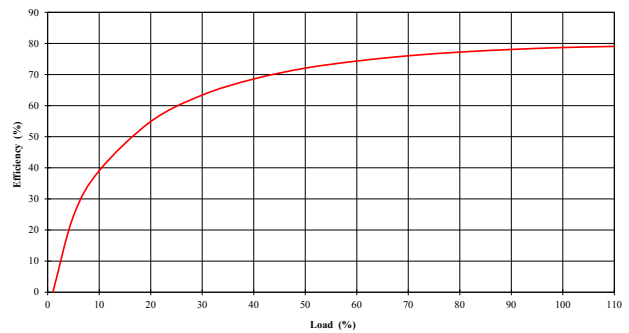

DERATING GRAPHS

NXE2S0505MC

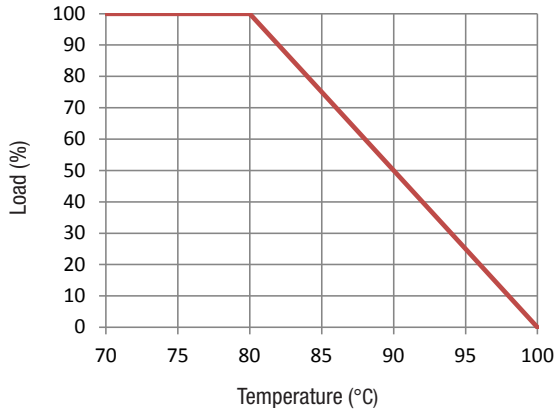

NXE2S1205MC

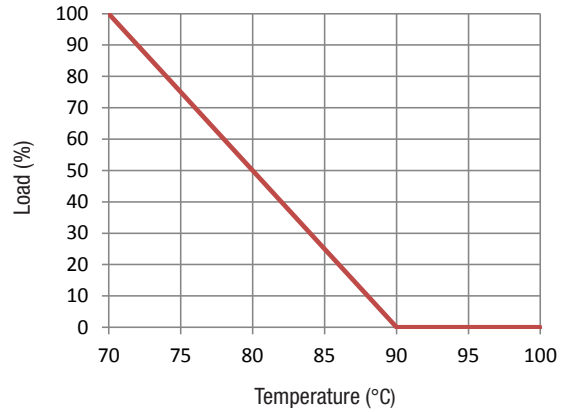

NXE2S1212MC

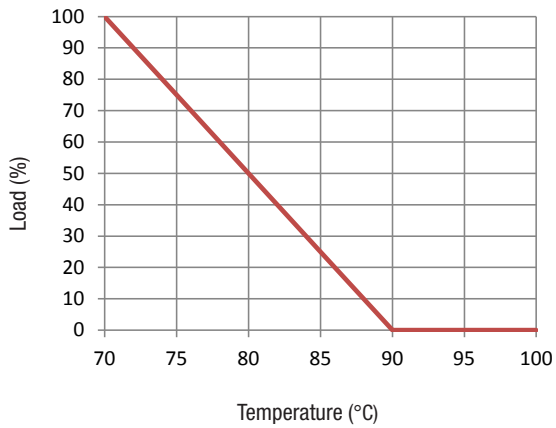

NXE2S1215MC

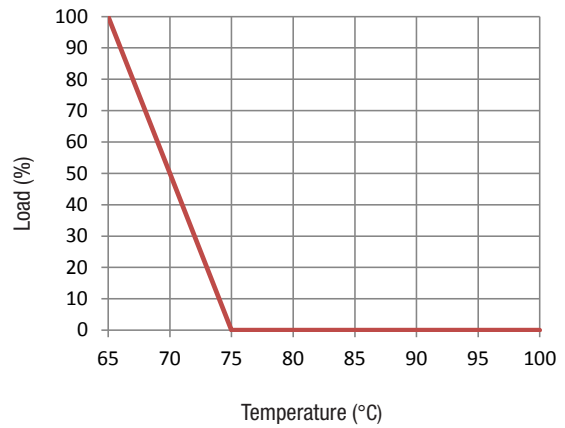

APPLICATION NOTES

Short Circuit Performance

The NXE2S0505MC offers short circuit protection at low ambient temperatures from -40°C to the temperatures shown in the below graph. The NXE2S12XXMC variants offer only momentary short circuit protection.

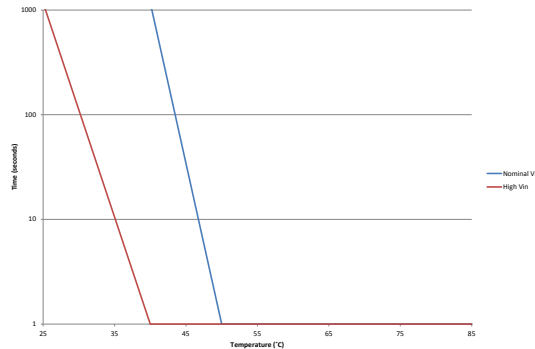

Advisory Notes

The NXE2 series is not hermetically sealed, customers should ensure that parts are fully dried before input power application.

Minimum Load

The minimum load to meet datasheet specification is 10% of the full rated load across the specified input voltage range. Lower than 10% minimum loading will result in an increase in output voltage, which may rise to typically double the specified output voltage if the output load falls to less than 5%.

Capacitive Loading & Start Up

Typical start up times for this series, with a typical input voltage rise time of 2.2µs and output capacitance of 10µF, are shown in the table below. The product series will start into a capacitance of 47µF with an increased start time, however, the maximum recommended output capacitance is 10µF.

	Start-up time µS
NXE2S0505MC	260
NXE2S1205MC	160
NXE2S1212MC	550
NXE2S1215MC	870

Typical Start-Up Wave Form

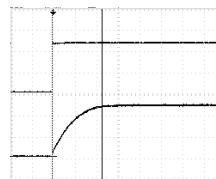

Output Ripple Reduction

By using the values of inductance and capacitance stated, the output ripple at the rated load is lowered to 5mV p-p max.

Component selection

Capacitor: It is required that the ESR (Equivalent Series Resistance) should be as low as possible, ceramic types are recommended. The voltage rating should be at least twice (except for 15V output), the rated output voltage of the DC/DC converter.

Inductor: The rated current of the inductor should not be less than that of the output of the DC/DC converter. At the rated current, the DC resistance of the inductor should be such that the voltage drop across the inductor is <2% of the rated voltage of the DC/DC converter. The SRF (Self Resonant Frequency) should be >20MHz.

	Inductor			Capacitor
	L, µH	SMD	Through Hole	C, µF
NXE2S0505MC	22	82223C	15223C	10
NXE2S1205MC	22	82223C	15223C	10
NXE2S1212MC	22	82223C	15223C	10
NXE2S1215MC	22	82223C	15223C	47

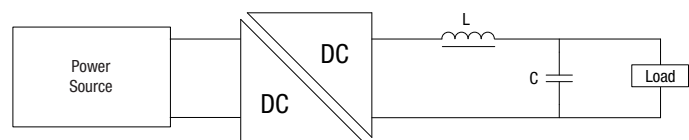

EMC FILTERING AND SPECTRA

FILTERING

The following table shows the additional input capacitor and input inductor typically required to meet EN 55022 Curve B Quasi-Peak EMC limit, as shown in the following plots.

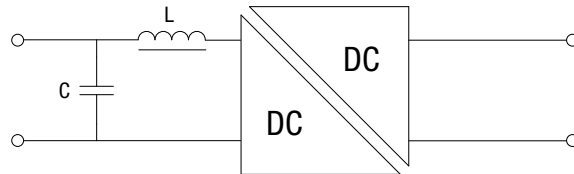

Part Number	Capacitor	Inductor
NXE2S0505MC	4.7µF	15µH
NXE2S1205MC	4.7µF	15µH
NXE2S1212MC	3.3µF	10µH
NXE2S1215MC	3.3µF	22µH

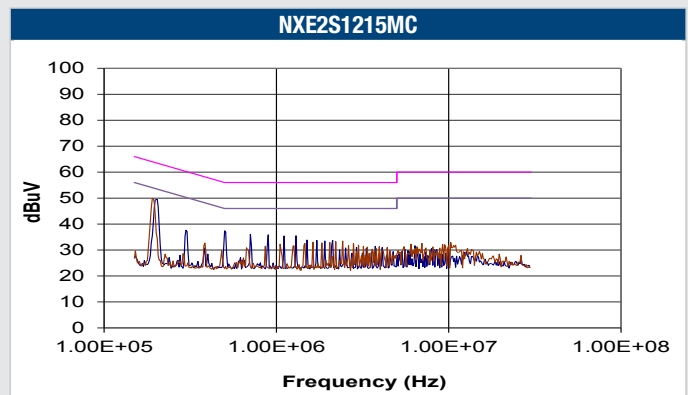
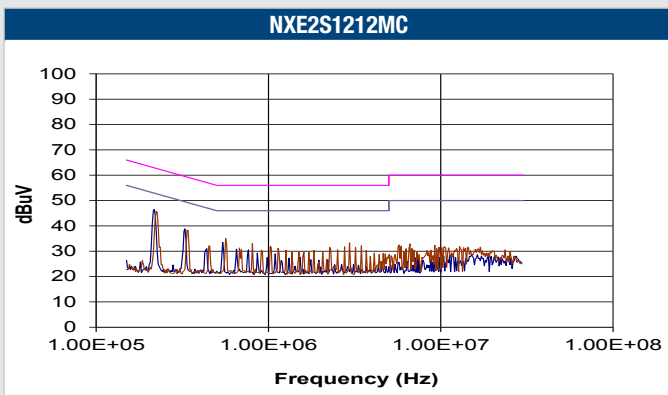
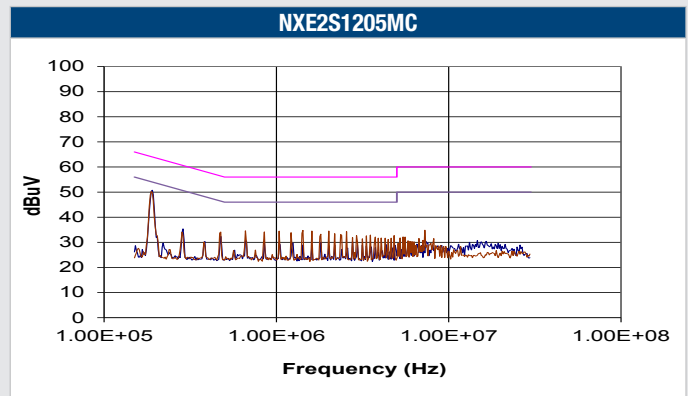
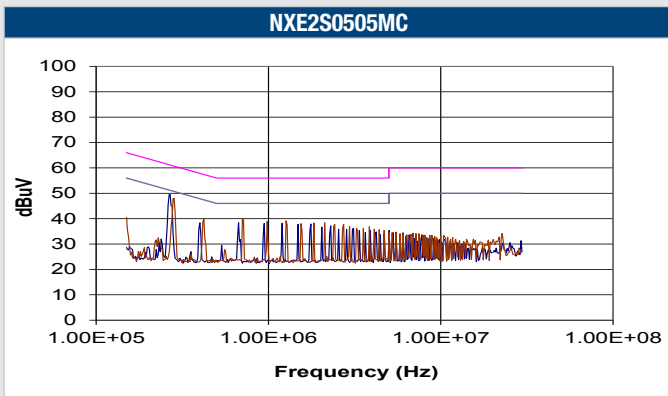

PACKAGE SPECIFICATIONS

Mechanical Dimensions

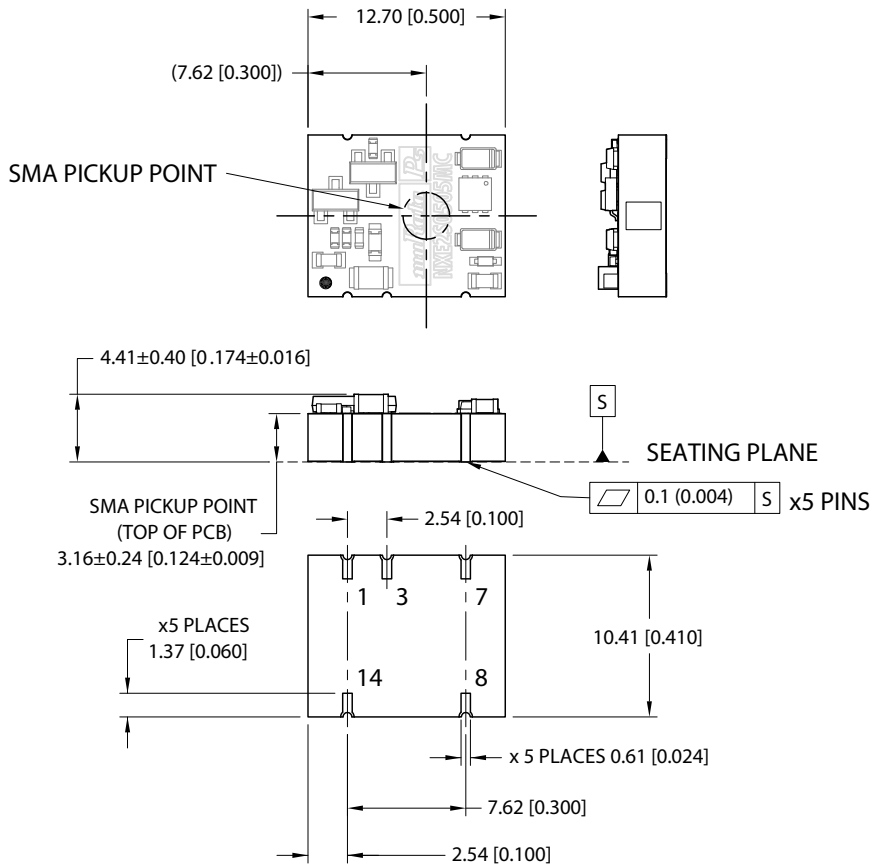

Pin Connections

Pin	Function
1	-Vin
3	+Vin
7	-Vout
8	+Vout
14	NA

NA - Not available for electrical connection.

All dimensions in mm(inches), Controlling dimension is mm. Tolerances (unless otherwise stated) ±0.10(0.004).

Weight: 1.1g

Recommended Footprint Details

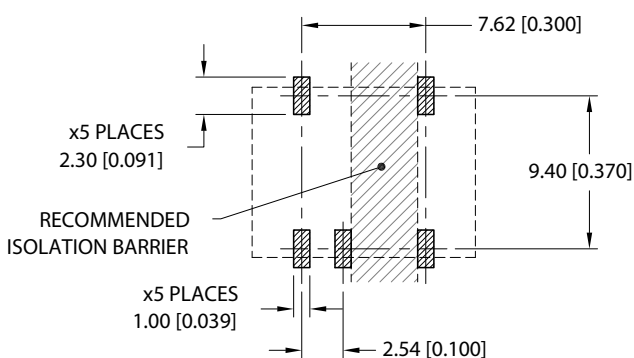

TAPE & REEL SPECIFICATIONS

REEL OUTLINE DIMENSIONS

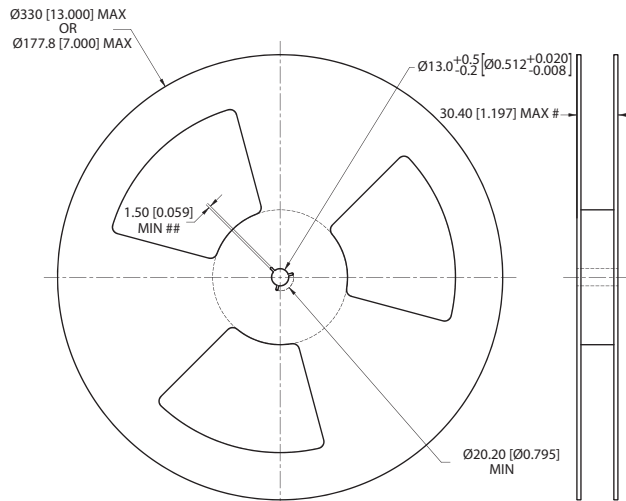

Tape & Reel specifications shall conform with current EIA-481 standard
 Unless otherwise stated all dimensions in mm (inches)
 Controlling dimension is mm
 # Measured at hub
 ## Six equi-spaced slots on 180mm/7" reel

REEL PACKAGING DETAILS

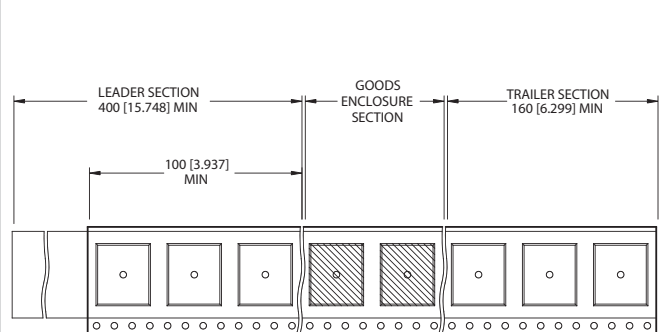

Carrier tape pockets shown are illustrative only - Refer to carrier tape diagram for actual pocket details.
 Reel Quantity: 7" - 180 or 13" - 800

TAPE OUTLINE DIMENSIONS

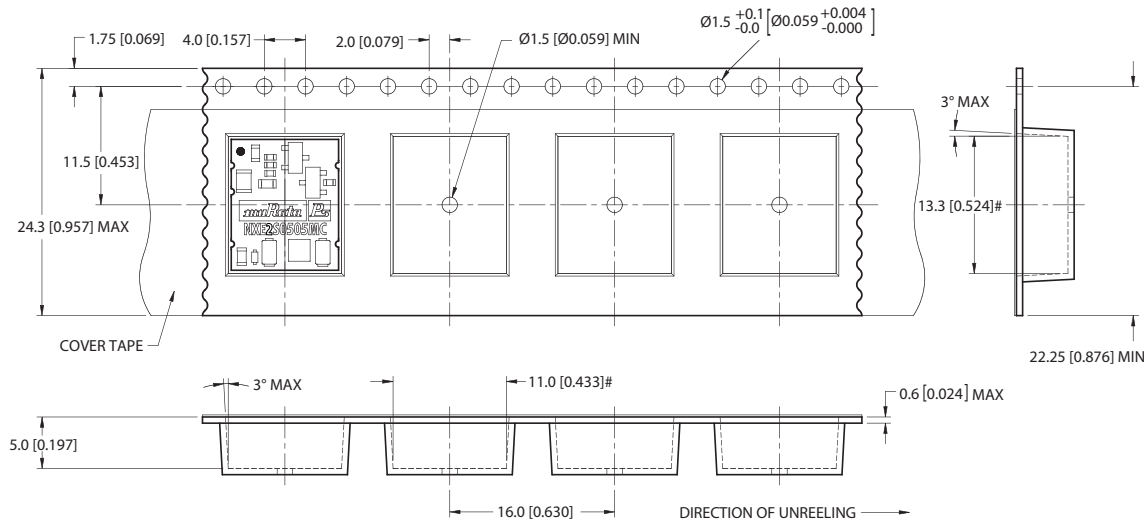

Tape & Reel specifications shall conform with current EIA-481 standard
 Unless otherwise stated all dimensions in mm (inches) ±0.1mm (±0.004 Inches)
 Controlling dimension is mm
 Components shall be orientated within the carrier tape as indicated
 # Measured on a plane 0.3mm above the bottom pocket

Murata Power Solutions, Inc.
 11 Cabot Boulevard, Mansfield, MA 02048-1151 U.S.A.
 ISO 9001 and 14001 REGISTERED



This product is subject to the following **operating requirements** and the **Life and Safety Critical Application Sales Policy**:
 Refer to: <http://www.murata-ps.com/requirements/>

Murata Power Solutions, Inc. makes no representation that the use of its products in the circuits described herein, or the use of other technical information contained herein, will not infringe upon existing or future patent rights. The descriptions contained herein do not imply the granting of licenses to make, use, or sell equipment constructed in accordance therewith. Specifications are subject to change without notice. © 2016 Murata Power Solutions, Inc.

Mouser Electronics

Authorized Distributor

Click to View Pricing, Inventory, Delivery & Lifecycle Information:

[Murata:](#)

[NXE2S1205MC-R7](#) [NXE2S1212MC-R7](#) [NXE2S0505MC-R7](#) [NXE2S1215MC-R7](#)